



DECLARATION OF CONFORMITY WE



According to the Decree of the Minister of Economy of 21 October 2008 on essential requirements for equipment (Journal of Laws No. 199, item. 1228) and a Directive of the European Parliament and Council Directive 2006/42 / WE

JAR-MET Spółka Jawna
Dariusz Sińczuk, Tomasz Sternicki
Ul. T. Kościuszki 94, 07-100 Węgrów

The person responsible for preparation of technical documentation machines:

First name and last name
address

acting as a producer, I declare with full responsibility that the:

Machine: 1-ROTOR RAKER

Type/model:

Serial number :

Year of production:

Function:

to which this declaration relates, complies with all relevant provisions contained in:

Directive of the European Parliament and Council Directive 2006/42 / WE of 17 May 2006 on machinery (Acts. Office. The EU L157, of 09.06.2006, p. 24-86);

Regulation of the Minister of Economy of 21 October 2008. On essential requirements for machines (Dz. U. 199, item. 1228)

To the conformity evaluation the following harmonized standards:

PN-EN ISO 4254-10:2011

PN-EN ISO 12100:2012

PN-EN ISO 4254-1:2013

and the standards and regulations:

PN- ISO 3600:1998

PN – ISO 11684:1998

Statement of the Minister of Transport, Construction and Maritime Economy of 6 June 2013 on a uniform text of the Regulation of the Minister of Infrastructure on the technical specifications of vehicles and their necessary equipment (Dz. U. item. 951/2013)

This declaration of conformity loses its validity, if the machine is changed or converted without the manufacturer's consent

An integral element of the machine is manual.

Transfer of machinery to another person only possible in a position to full fitness technical, accompanied by the instruction manual and declaration of conformity.

Węgrów,

Place and date of issue

.....
Name and function of the signatory

JAR-MET®



DECLARATION OF CONFORMITY WE



According to the Decree of the Minister of Economy of 21 October 2008 on essential requirements for equipment (Journal of Laws No. 199, item. 1228) and a Directive of the European Parliament and Council Directive 2006/42 / WE

JAR-MET Spółka Jawna
Dariusz Sińczuk, Tomasz Sternicki
Ul. T. Kościuszki 94, 07-100 Węgrów

The person responsible for preparation of technical documentation machines:

First name and last name
address

acting as a producer, I declare with full responsibility that the:

Machine: 1-ROTOR RAKER

Type/model:

Serial number :

Year of production:

Function:

to which this declaration relates, complies with all relevant provisions contained in:

Directive of the European Parliament and Council Directive 2006/42 / WE of 17 May 2006 on machinery (Acts. Office. The EU L157, of 09.06.2006, p. 24-86);

Regulation of the Minister of Economy of 21 October 2008. On essential requirements for machines (Dz. U. 199, item. 1228)

To the conformity evaluation the following harmonized standards:

PN-EN ISO 4254-10:2011

PN-EN ISO 12100:2012

PN-EN ISO 4254-1:2013

and the standards and regulations:

PN- ISO 3600:1998

PN – ISO 11684:1998

Statement of the Minister of Transport, Construction and Maritime Economy of 6 June 2013 on a uniform text of the Regulation of the Minister of Infrastructure on the technical specifications of vehicles and their necessary equipment (Dz. U. item. 951/2013)

This declaration of conformity loses its validity, if the machine is changed or converted without the manufacturer's consent

An integral element of the machine is manual.

Transfer of machinery to another person only possible in a position to full fitness technical, accompanied by the instruction manual and declaration of conformity.

Węgrów,

Place and date of issue

.....
Name and function of the signatory

JAR-MET®



JAR-MET Spółka Jawna
Dariusz Sińczuk, Tomasz Sternicki
ul. T.Kościuszki 94, 07-100 Węgrów
tel. (25) 792 25 25
<http://www.jar-met.pl>; e-mail: jar-met@jar-met.pl

**Declaration of conformity WE
for a machine**

According to the Ordinance of Minister of Economy of 21 October 2008
(Journal of Laws "Dziennik Ustaw" No 199, item 1228) and European Union Directive
2006/42/WE of 17 May 2006

we declare with full responsibility that the machine:

Machine: **1-rotor raker**
Type/Model: **Z206**
Year of production:

to which this declaration relates, is in conformity with:

the **Ordinance** of Minister of Economy of 21 October 2008 on essential requirements for
machines (Journal of Laws "Dziennik Ustaw" No 199, item 1228) and European Union
Directive 2006/42/WE of 17 May 2006

Following harmonized standards have been applied:

PN-EN ISO 12100-1:2005
PN-EN ISO 12100-2:2005
PN-EN 294-1994
PN-EN 1553:2002

This Declaration of Conformity WE loses its validity if the product is misused or modified
without proper authorization.

Węgrów,
Place and date of issue

.....
Name and function of the signatory

IDENTIFICATION

1-rotor raker

Mountable 1-rotor carousel raker has a rating plate, fitted in the front part of the frame on the left side. Basic data which serves for identification of the machine is put there: manufacturer's name, machine symbol, serial number, year of production.

Data placed on the rating plate serves for identification of the raker and ought to correspond to the following data, filled in during the sales.

Symbol.....

Year of production.....

Serial number.....



IT IS ADVISED THAT THE SUPPLIER OF A MACHINE, BOTH NEW AND USED ONES, KEEP THE SIGNED BY THE PURCHASER CONFIRMATION OF RECEIPT OF MANUAL ALONG WITH THE MACHINE



THE MANUAL CONSTITUTES MACHINE BASIC EQUIPMENT

KEEP THIS INSTRUCTION FOR FUTURE REFERENCE

TABLE OF CONTENTS

1. INTRODUCTION.....	9
2. INTENDED USE OF THE RAKER.....	9
3. SAFETY PRECAUTIONS AND WARNINGS.....	10
3.1.Symbols: meaning and application.....	10
3.2. Expected use.....	10
3.3. Expected threats in operating the raker.....	11
3.4. Other risk elements.....	11
3.5. Regulations for occupational health and safety.....	12
3.6. Standard conformity.....	14
3.7. Manufacturer’s responsibility and guaranty.....	15
3.8. Noise and vibrations.....	15
3.9. Safety signs and captions.....	16
4. USAGE REGULATIONS.....	17
4.1. General information.....	17
4.2. Construction and operation of the raker.....	17
4.3. Equipment and fittings.....	18
4.4. Preparing a tractor to work.....	18
4.4.1. PTO shaft assembly.....	19
4.5. Raker assembly.....	19
4.5.1. Assembly of raker arms.....	19
4.5.2. Assembly of protective barriers and shield.....	19
4.6. Preparing a raker to work.....	20
4.6. Mounting a carousel raker on the tractor.....	20
4.7. Changing transportation-operation position.....	20
4.8. Raker adjustment regulations.....	21
4.9. Work with a carousel raker.....	21
5. TECHNICAL OPERATION OF THE RAKER.....	22
5.1. Instructions on maintenance of a raker.....	22
5.1.1. Tires.....	22
5.2. After-seasonal maintenance instructions.....	22
5.3. Lubrication instruction.....	22
5.4. Raker storage.....	23

5.6. Possible failure.....	23
6. TRANSPORTATION OF A CAROUSEL RAKER.....	23
6.1. Raker transportation by means of transport.....	23
6.2. Transportation of a raker on the tractor three-point suspension system	24
7. DISASSEMBLY.....	24
8. TOTALING.....	25
9. TECHNICAL CHARACTERISTICS.....	25
SPARE PARTS CATALOGUE.....	26
NOTES.....	28
WARRANTY CARD.....	29

JAR-MET®

1. INTRODUCTION

This manual is attached to each machine to make a user acquainted with construction, operation and adjustment of the 1-rotor raker. Its aim is also warning about existing or possible threats. The manual also contains information on preparation to transport on public roads.

Strict compliance with recommendations included in the content of the instruction will ensure long-term and non-failure operation and contribute to reduction of operating costs of the machine.

Each chapter of the instruction (according to the contents) presents proper issues in detail. If there is any unclear information for the user, they can obtain exhaustive explanation by writing to the manufacturer's address (the address is on the cover) – you are asked to give: exact address of the purchaser of the machine, machine symbol, serial number, year of production, year and number of issuing the manual.

Terms used in the manual: left side, right side, back and front – refer to the settings of an observer with his face turned according to the direction of the machine drive.

Warranty proceedings regulations and rights resulting from them, are given in the warranty card, attached to each carousel raker.

2. INTENDED USE OF THE RAKER

Suspended 1-rotor carousel raker is intended to operate exclusively in the agriculture, to rake mown plant material. Using it for other purposes shall be understood as using it against the intended use. Meeting requirements referring to operation of the machine, its maintenance and repairs according to recommendations of the manufacturer and strictly complying to them states the condition of using it according to the intended use.

The machine shall be employed, operated and repaired only by people acquainted with its detailed characteristics and with procedures in the field of safety.

Regulations concerning accidents prevention and all the basic regulations in the field of occupational health and safety and also traffic regulations should be always abided by.

Unauthorized modifications introduced to the machine without the manufacturer's consent absolve the manufacturer from liability for any resulting damages and harms and entail a loss of warranty.

1-rotor carousel raker is intended to rake mown plant material (for example low-stem green plants and dried hay). Simple construction and user-friendly operation are advantages of this machine.

1-rotor carousel raker is a machine suspended on a three-point suspension system of a tractor, drive is gained from tractor power take-off shaft and should cooperate with tractors of 0.6 class and larger.

3. SAFETY PRECAUTIONS AND WARNINGS

3.1. Symbols: meaning and application

In the present manual symbols are used in order to draw the reader's attention and stress certain particularly important aspects requiring discussion.



DANGER

This indicates danger, with a possible serious accident risk. Not obeying recommendations marked with this sign may cause a situation of a serious risk of sustaining an injury by the operator and/or people nearby!

Obey strictly these recommendations!

CAUTION

The symbol indicates possibility of damaging the machine or other personal object of the operator and demands to be cautious. It is important advice which should be paid special attention!

REMEMBER

The symbol indicates advice or notice regarding key functions or useful information concerning proper functioning of the machine.

3.2. Expected use



1-rotor raker of JAR-MET company has been designed, built and adjusted for operation in agricultural production. It serves for raking freshly mown, low-stem green plants and dried hay. The machine works after connecting it to a tractor and is driven from power take-off shaft through the PTO shaft. 1-rotor raker should be aggregated only with recommended tractors classes, see technical characteristics.



REMEMBER

Regulations concerning the intended use and configurations, provided for this machine are the only ones, which are exclusively allowed. The machine shall not be employed for other purposes than those, which have been provided for it. The regulations given in this manual do not substitute obligation towards present regulations with force of a statute, referring to standards concerning safety and prevention from misadventure, but they summarize them.



CAUTION

When lending the carousel raker to another person, the manual shall be attached to the machine.

3.3 Expected threats in operating the raker

When operating a 1-rotor raker according to the intended use, some threats for human life and health can be predicted. In order to avoid occurring threats, it is essential to become acquainted with usage regulations and operation of the raker in detail. It is necessary to pay special attention to raker assemblies and situations posing threats for the operator, people nearby and surrounding:

- rotating arms with spring fingers,
- rotating PTO shaft,
- mechanical threat caused by hitting or abrasion of the raker construction elements,
- threat resulting from being crushed during the operator's staying near the tractor lower rods while connecting the machine to the tractor,
- threat resulting from throwing out stones or soil lumps by spring fingers,
- threat resulting from machine stability loss.

3.4. Other risk elements



Although  company takes responsibility for pattern-designing, construction in order to eliminate danger, however certain risk elements during the 1-rotor raker operation are unavoidable.



Danger of being caught or hurt by sticking-out raker parts during technical operation or work. Before beginning the above activities, it is necessary to make sure there are no people nearby.



Danger of being squeezed during aggregation, lifting or lowering the raker. Keep extreme caution during performing these activities, check whether there are any people within the reach of the machine.



Danger of being pulled into or caught by rotating drive parts and raker spring teeth. Keep safe distance when the rotating parts are in motion. The operator and other people shall not approach the machine while it is operating.



Danger of throwing items by the raker during operation. Keep extreme caution during the machine operation. The operator and other people should not approach the machine during its operation. Keep safe distance from the operating machine.



Danger of stability loss. When stored, the raker should be set on the tough and flat ground and the support lowered. The raker shall be aggregated with recommended tractors.

3.5. Regulations for occupational health and safety



CAUTION

In order to avoid threats, before starting operation of the raker, please read the present manual and follow these rules concerning threats and safety measures:

General regulations

- Apart from this manual, one shall also follow traffic regulations and occupational safety and health regulations.
- Warnings (pictograms) placed on the raker give advice concerning safety of the user and other people, and avoiding accidents.
- When driving on public roads, it is obligatory to follow regulations included in Highway Code.
- The user must avoid wearing too loose clothing, which might be pulled into by rotating parts of the raker.
- It is advised to cooperate with a tractor equipped with a cabin or a protective frame.
- Before each using the machine, it is necessary to check if all protective devices are in a good condition. Damage incurred shall be fixed without delay and possible deficiencies filled up.
- Avoid staying within the range of operating raker.
- Before leaving the tractor cabin and before each activity made near the raker, turn off the tractor engine, remove the key from the ignition switch and make sure all the rotating assemblies have stopped.
- The raker shall be stored in a dry room, on tough and flat ground. During lowering the raker onto the ground, keep particular caution. Danger of injury!!!

Aggregation

- Keep particular caution during connecting a 1-rotor raker with a tractor and during disconnection.
- It is forbidden to stay between a raker and a tractor during any activities performed with a hydraulic system lever.
- Before connecting the raker, check if the pressure on the front of the tractor is sufficient in accordance with the manual and conditions made by the tractor manufacturer.
- Keep the minimum load of the tractor front, ensuring the front axle pressure, equaling minimum 20% of the tractor weight itself is the condition of keeping the tractor controllability.



CAUTION

Operation with other than recommended by the manufacturer tractor may cause threat of stability loss in operation or in stoppage.

- The raker can be operated by a person with qualifications allowing for using agricultural tractors.

- It is not allowed to permit other people who are not familiar with the manual to use the raker. During aggregation of the raker with a tractor or performing any repairs in the assembly, stop the engine, remove the key from the ignition switch and pull hand brake.
- The raker shall be aggregated with recommended tractors equipped with standard front axle ballasts in accordance with data given in the technical characteristics of the tractor.
- While connecting the raker with a tractor, keep extreme caution, it is forbidden to stay between the machine and a tractor during the engine operation.
- Use standard cotter pins to connect three-point suspension system of the machine with a tractor.
- Use recommended PTO shaft. Operation with the PTO shaft without a shield or with a damaged shield is forbidden.
- Shaft shield shall be protected against the rotation with a chain.



CAUTION

Operation with the recommended PTO shaft guarantees overlapping of the take-off shaft shield with a PTO shaft shield by at least 50 mm at each side.

Maintenance

- The raker can be operated by a person with qualifications allowing for using agricultural tractors and acquainted with the raker manual.
- Operation without shields, and protective barriers of the rotor is not allowed.
- Check if bolts fastening canvas apron, rotor arms and spring fingers are not loose and in case of backlash, tighten the bolts.
- Lift the raker to the transportation position (clearance 300 mm), further lifting may damage the open rear window of the tractor cabin.
- All maintenance shall be done with the raker lowered to the ground, the engine stopped, key taken out from the ignition switch and hand brake pulled.
- All maintenance connected with lubrication, repairs and cleaning of the machine should be performed with the raker lowered onto the ground and the tractor engine stopped.
- During the first run, check the raker operation and make initial adjustment.
- It is forbidden for the operator to stay between a tractor and the raker with the tractor engine running.
- Clean the raker after each use and before performing maintenance.
- It is not allowed to transport any people or items on the carousel raker.
- During operation with a raker, it must not be weighted with additional mass.
- Work on slopes with gradient exceeding 8.5° is not allowed.
- While making returns, keep extreme caution and reduce speed to the necessary minimum.
- During operation of the 1-rotor raker it is prohibited to insert hands into the operation area of the rotor and spring fingers.
- It is prohibited to perform any raking procedures if there are any people within the distance of less than 20 m from the machine.
- It is not allowed to exceed permissible rotations of power take-off shaft – 540 rpm.

- When returning or reversing, always turn off the drive and lift the raker.
- It is not allowed to use tractor reverse gear during operation, when the machine is in the working position.
- Removing clogging can be performed after stopping the tractor and turning off the engine and after stopping machine rotating elements.

Storage

- Disconnecting a raker from a tractor can be performed only after stopping tractor engine.
- The raker shall be stored in a clean condition.
- The raker should be stored in a place where there is no possibility of accidental injury of people or animals, on the flat ground, preferably under a roof.
- The raker shall be stored in a dry room, on the tough and flat ground. When lowering the raker onto the ground, keep extreme caution – danger of injury!!!

Transportation

- The transportation of a raker by means of transport from the manufacturer to the sales person or the client is described in the chapter ‘Raker transportation’ in detail. One shall remember safety rules during the loading and proper fixing of the raker on a car trailer. Hooks for ropes or chains can be found at the ends of the raker frame and are marked with pictograms.
- Raker transported on public roads must be equipped with portable light and warning devices and a triangular sign for low-speed vehicles, installed in special handles on the machine frame, see details in chapter ‘Raker transportation’.
- It is forbidden to transport people or items on the raker during transportation or work.
- Before driving on a public road and starting work, check the nearest area of the tractor and the raker, if there are any unwanted people (children!). Dismiss each person and animal from the danger zone of the working raker.
- Before driving on public roads check operation of light signals in portable light devices required by regulations in the Highway Code.
- Keep extreme caution while making a turn with a tractor with a suspended carousel raker, during transportation and also while making returns in the field, especially when there are any people, animals or items nearby.

Others

- It is not allowed to use the 1-rotor carousel raker for other purposes than given in the manual.

Not following these rules may cause threat to the operator and other people and also may cause damage to the raker. Any damage resulting from not following these rules is the only responsibility of the user.

3.6. Standard conformity

The machine has been designed and made in accordance with standards concerning safety in the machine industry, valid on the day of marketing the raker. Particularly, following legal acts and harmonized standards have been taken into account:

- 2006/42/WE –Directive on machinery safety introduced by the Ordinance of Minister of Economy on 21 October 2008 (Journal of Laws ‘Dziennik Ustaw’ No 199, item 1228).

- PN-EN ISO 12100-1:2005 – Machinery. Safety. Basic concepts, general principles for design. Basic terminology, methodology.
- PN-EN ISO 12100-2:2005 – Machinery. Safety. Basic concepts, general principles for design. Principles and technical requirements.
- PN-EN 294 – Safety of machinery. Safety distances to prevent danger zones being reached by the upper limbs.
- PE-EN 1050 – Machinery. Safety. Risk assessment rules.
- PN-EN 1553 - Agricultural machinery. Agricultural self-propelled, mounted, semi-mounted and trailed machines. Common safety requirements.
- PN-ISO 3600 – Tractors, agricultural and forest machinery, mototools. Manual. Contents and form.
- PN-ISO 4254-9 – Tractors, agricultural and forest machinery. Technical measures of ensuring safety. Devices for seeding, tillage and fertilization.
- PN-ISO 11684 – Tractors, agricultural and forest machinery, mototools. Safety and warning signs. General principles.

3.7. Manufacturer's responsibility and guarantee



In relation to described in this manual type of machine,  company does not acknowledge any civil responsibility towards:

- improper or inconsistent with the manufacturer's recommendations using the machine,
- using the machine in a way breaking domestic law concerning safety and preventing unfortunate accidents,
- making unauthorized changes in the machine,
- non-compliance or improper following regulations cited in this manual,
- using the machine by unqualified staff,
- using spare parts that are not original.

As long as the purchaser wants to make use of warranty, he should strictly follow recommendations and regulations given in the manual. In particular:

- he should work only in the given ranges of the machine operation,
- he can allow operators only with proper skills and qualifications to use the machine,
- he should always perform unchangeable and thorough maintenance,
- he should use only original spare parts recommended by the manufacturer.

3.8. Noise and trembling

During the operation of 1-rotor carousel raker for the operator there is no threat caused by noise contributing to the loss of hearing because the workplace of the operator is in the tractor cabin. During measurement of noise level made at the machine stoppage, in accordance with appendix D to the standard PN-EN 1553:2002, noise level of 1-rotor raker does not exceed 75 dB (A).

There is no threat caused by vibrations when working with the 1-rotor carousel raker because the operator's workplace is located in the tractor cabin where the seat is amortized and ergonomically shaped.

3.9. Safety signs and captions











1-rotor carousel raker of JAR-MET company is equipped with all devices that ensure safe work. Where it is not possible to secure dangerous places entirely due to the proper operation of the machine, there are warning signs – pictograms which indicate for possibility of danger and present manners of avoiding it.

In table 1 pictograms placed on the machine and their meaning have been specified. Safety signs should be protected against being lost and against loss of legibility. Lost or illegible signs and captions should be replaced with new ones. It is required that new assemblies used during repair were marked with all safety signs predicted by the manufacturer.

In case of damaged or lost pictograms, new ones can be purchased by writing to the manufacturer's address and giving the sign number (according to the table 1) and version of the manual.

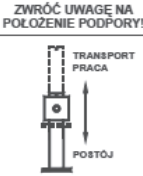
Table 1. Safety signs and captions

No.	Pictogram	Meaning	Location
1	2	3	4
1.	(Rating plate)	Rating plate	On the left side on the frame
2.	CAUTION ROTATING ELEMENTS	Warning against rotating elements of the raker	In the back part of the main frame
3.		Before starting work, read the manual.	On the left side on the machine frame.
4.		Turn off the engine and remove the key from the ignition switch before starting maintenance or repairs.	On the right side on the machine frame.
5.		Do not stay near the lift rods, while controlling the lift.	On the left side on the machine frame.
6.		Thrown out or flown out items - threat posed to the whole body. Keep safe distance from the machine.	At the back on the frame at the left rotor.

7.		Possibility of drawing in a leg. Keep a safe distance from the machine.	At the back on the frame at the right rotor.
8.		Pay attention to position of the support! Position of the support during stoppage and during transportation and machine operation.	On the frame above the support
9.		Information on rotational speed of power take-off shaft and direction of rotations.	On the shield of power input connection.
10.		Marking places of loading hooks.	On frame elements.
11.		JAR-MET Spółka Jawna Dariusz Sińczuk, Tomasz Sternicki ul. T. Kościuszki 94, 07-100 Węgrów tel. (025) 792 25 25	On the machine frame.

4. USAGE REGULATIONS

4.1. General information

1-rotor carousel raker Z206 is a suspended machine, suitable for use on terrain slopes not exceeding 8.5° and cooperating with tractors class 0.6 and higher, equipped with a set of standard ballasts.

To the raker drive it is necessary to use PTO shaft having the required CE safety marking and proper technical parameters recommended by the manufacturer (6 spline connection, large 2, nominal torque 250 Nm, nominal transmitted power 14 kW). Technical data of the shaft is included in the table 2. Due to the risk of overloading the shaft, it shall not be used for drive in other machines.

4.2. Construction and operation of the raker

1-rotor carousel raker Z206 is a machine suspended on the three-point suspension system of the tractor, gaining drive from its power take-off shaft (figure 1). A raker consists of a frame (1), to which one working unit with diameter about 2.8 m is attached. Working unit consists of arms (2), to each three double spring fingers (3), comprising raking bars are attached. At the other end of the arms there is a cranked shaft with rollers (4). These rollers cooperate with a cam follower track, which results in a change of inclination angle of fingers in relation to the field surface. During one rotation inclination angle of fingers changes from almost vertical position to similar to horizontal one. In the vertical position, fingers rake plant material while when approaching to the shield (5), they turn to the horizontal position. At horizontal setting, the fingers lose contact with the raked material, which results in forming a bale.

Arms gain drive from the tractor power take-off shaft on the machine power input connection and through the drive shaft on bevel gear.

Support wheels (6) copy terrain inequality and ensure working clearance to spring fingers. In order to perform better copying of the terrain, the manufacturer, upon a special request of a client for additional charge, can equip the machine with a wheels and steering system of tandem type. To the frame of the machine there are protective barriers (7) screwed protecting access to rotating working elements. At the back on the machine frame there are handles for light and warning signs and a triangular sign for low-speed vehicles attached.

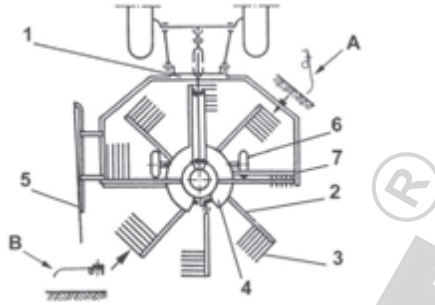

Figure 1. 1-rotor carousel raker – general view, 1 – frame, 2 – arms, 3 – spring fingers, 4 – cranked shaft with rollers, 5 – shield, 6 – supporting wheels, 7 – protective barriers, A – vertical setting of fingers (beginning of raking), B – horizontal setting of fingers (end of raking)

4.3. Equipment and fittings

Manual with spare parts catalogue and a warranty card comprise basic equipment of 1-rotor raker.

Basic equipment of the machine **does not involve** PTO shaft, portable light and warning devices and a triangle sign for low-speed vehicles. The equipment is available at agricultural equipment storehouses.

Each user of a raker should have light and warning signs, in working order, and a triangular sign for low-speed vehicles (sign description is available in the chapter ‘Transportation of a raker on the tractor suspension system’). Not having them during transportation may result in an accident. For damage incurred only the user of the machine is responsible.

4.4. Preparing the tractor to work

Preparation of the tractor to cooperation with a raker consists in checking its general efficiency in accordance with the tractor manual (pay particular attention to the proper operation of tool suspension system). It is necessary to aggregate the raker with tractors of recommended classes equipped with standard ballasts of front axle and rear wheels in accordance with the technical characteristics of a tractor.

Air pressure, particularly in rear tires of the tractor must be equal in both wheels and in accordance with the tractor’s manual!

Before suspension of the machine, lower rods of the tractor’s suspension system should be set in lower position on the same height (distance between joints and ground is minimum 200 mm). Rods set on the equal height from the ground facilitate suspending the carousel raker on the tractor.

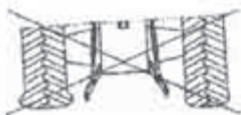

Suspension of devices on the rear three-point suspension system cannot lead to exceed permissible load on the axle or capacity of the tractor’s tires. Controllability factor should

equal more than 0.2 that is ballast of the tractor's front axle with a mounted raker should comprise more than 20% of the weight of, ready to work, tractor itself. If controllability factor is less than 0.2, it is necessary to put additional ballasts of the front axle.

4.4.1. Assembly of the PTO shaft



For 1-rotor carousel raker of JAR-MET company, the manufacturer recommends using PTO shafts, which carry minimum power 12 kW and torque 210 Nm. Detailed data is given in the technical characteristics.

Each time before starting work, it is necessary to check fastening of PTO shaft endings at the end of the power take-off shaft (of the tractor) and power input connection PIC (of the raker). Fasten the chain of PTO shaft shields to the power take-off shaft shield and PIC shield. Make sure the assembled PTO shaft is of the proper length. At not sufficient length, disconnection of the shaft may occur and at its excessive length its bending will occur.



CAUTION

Inclination angle of the PTO shaft on joints in working position cannot exceed 25°. It is forbidden to disassemble the shaft shifts.

4.5. Raker assembly

In some cases there is possibility of receiving a carousel raker disassembled into main subassemblies. Such a situation takes place during machine transportation from the manufacturer to a seller or a farmer, when the machine is transported on pallets.



REMEMBER

Assembly of the machine shall be performed only at the tractor engine stopped and the handbrake pulled.

4.5.1. Assembly of raker arms

At the beginning of the assembly of the raker, put the frame of the machine suspension system on the tractor and then insert a support in the handle which is on the frame of the machine three-point suspension system. The support shall be protected with a spring pin so that the machine did not fall down and kept the proper height over the ground.

Arms with spring fingers are installed for transportation on the tractor in special handles on the machine frame and protected with cotter pins.

4.5.2. Assembly of protective barriers and shield

Protective barriers protect against possible accidents during operation of the machine. Two protective barriers shall be attached to the machine frame. On the left side of the machine, there is a shield forming windrow installed. It is necessary to pay attention so that endings of the protective barriers were closed with a plug. The assembly should be performed in accordance with figures in the parts catalogue.

4.6. Preparing the raker to work

Preparation of 1-rotor carousel raker to work consists in checking its technical condition and first of all firmness of connections of spring fingers with arms. In case of stating any damages or worn spring fingers, they shall be exchanged into new or regenerated ones. Otherwise, it can lead to quality reduction of the tool work or its damage. Furthermore, it is necessary to:

- check if the shield with arms and fingers rotate easily and without jamming,
- check if road wheels rotate easily and without jamming.



REMEMBER

Each time before work, firmness of connections of spring fingers with arms shall be checked.

4.6. Mounting a carousel raker on the tractor

Mounting a carousel raker on the tractor three-point suspension system, perform following activities:

- disassemble tool drawbar from the lower rods of the tractor three-point suspension system,
- drive the tractor closely enough to the machine frame,
- **turn off the tractor engine, remove the key from the ignition switch and pull handbrake,**
- put lower rods of the tractor (first left, then right ones) onto the raker studs and secure them with typical cotter pins,
- tighten side chains of tractor lower rods to avoid side deviations of the raker,
- using a pivot, link the upper connector of the tractor with the upper opening of the raker suspension system and secure with a typical cotter pin,
- put PTO shaft onto the ending of the raker power input connection and the ending of the tractor power take-off shaft (tractor – outer guard, machine – inner guard), fasten the chain of shaft shield to the power input connection shield of the machine and the tractor,
- lift the raker to the transportation position, maintaining recommended minimum transportation clearance 0.3,
- perform transversal leveling with the use of the right hanger of the tractor suspension system so that the machine frame was in a horizontal position,
- install portable light and warning signs and a triangular sign for low-speed vehicles.



CAUTION

It is forbidden to connect the raker to the tractor when the tractor engine is running. It is forbidden to use other elements to secure the tool suspension than those recommended by the manufacturer.

4.7. Changing transportation - operation position

Changing transportation-operation position should take place at the machine set on the ground. In order to perform the change of the position safely, do as follows:

- lower the raker onto the ground,
- disassemble portable light and warning signs and a triangle for low-speed vehicles,
- arms with spring fingers shall be installed on the rotor and secured with cotter pins,
- lower the protective barrier (right side) and protect with a cotter pin,
- lower the shield forming windrow (left side) and protect with a cotter pin.



CAUTION

When lowering the barrier and shield, pay particular attention to risk of being hit or crushed for other people.

4.8. Raker adjustment regulations

To ensure high quality of operation of 1-rotor carousel raker, the machine must be carefully adjusted. Basic regulation of the raker includes:

- transversal leveling,
- longitudinal leveling,
- regulation of the working height,
- regulation of the windrow width.

Transversal leveling – by regulating length of the tractor right hanger, set the machine so that the machine frame (from the rear view) is parallel to the ground. Arms on the right and left side should be on the same height over the ground.

Longitudinal leveling – is performed by changing the length of the upper connector so that (when viewed from the side), the machine frame is parallel to the ground. Arms at the front and back should be on the same height over the ground.

Regulation of working width – with the use of a knob for working height adjustment, set the required working height in order to gain proper parameters of raking. When the machine is lifted, turning the knob is easier.

Regulation of windrow width – take out the shield forming windrow to the required windrow width and protect with a bolt.

4.9. Work with a carousel raker

A raker shall be initiated in a scattered windrow of fodder only after gaining full rotations of working elements of the machine (rotational speed of tractor power take-off shaft 540 rpm). During operation it is advisable to keep engine rotations, corresponding with nominal rotations of power take-off shaft which are predicted for the given type of tractor and cooperate with the speed within the range of 6-12 km/h. Speed shall be chosen in dependence on local terrain conditions and kind of mown material. All clogging shall be removed at the raker stopped and the tractor engine stopped.



Figure 2. Scheme of carousel raker operation



DANGER

All maintenance (for example when jammed) shall be done with the machine lowered to the ground, rotating elements of the raker stopped and the tractor engine turned off, key removed from the ignition switch and the handbrake pulled.



CAUTION

It is not allowed to use reverse gear of the tractor during operation when the machine is in the working position.



WARNING

Before turning on the drive make sure that starting does not pose a threat to anyone. During operation do not allow people to approach the machine when it is in motion. It is forbidden to stay for the operator between the tractor and the raker at the tractor engine running.

The raker shall be raised easily, without jerks or vibrations.

5. TECHNICAL OPERATION OF THE RAKER

5.1. Instruction on maintenance of a raker

Each time, after work, clean the carousel raker of plant leftovers, and inspect connections of parts and units. Damaged and totally worn parts shall be replaced with new or regenerated ones. All loose screw connections should be tightened.

Light and warning signs and a triangular sign for low-speed vehicles shall be kept clean.

5.1.1. Tires

Maintenance connecting with repair of wheels and tires must be performed only by the qualified staff and only with the use of special tools. It is necessary to check pressure level in tires regularly and keep recommended pressure.



REMEMBER

Recommended pressure in tires type 15x6.00-6 4PR should equal 2.0 bar

5.2. After-season maintenance instructions

After season, the raker should be cleaned thoroughly out of contamination. Worn or damaged working parts should be exchanged and all loose screw connections tightened. Raker should be greased in accordance with the lubrication instruction.

Loss occurred in paint coat should be cleaned and filled by covering with a fresh layer of protective paint. The raker should be stored under roof on the flat, solid ground in a place posing no threat to people and surrounding.

5.3. Lubrication instruction

Basic lubrication activities of 1-rotor carousel raker are keeping lubrication periods and using proper types of grease. Before lubrication all the points of lubrication shall be cleaned of contamination. Lubrication shall be performed according to the table 2.

Used lubricants should be passed to a chain of points collecting them, where they are processed in order to be re-used.

Table 2. Lubrication points

No.	Lubrication points	Frequency	Grease type
1.	Rotor gear and bearing	every 50 h of work	LT-43
2.	Regulation knob	every 20 h of work	LT-43
3.	Shaft hub	every 20 h of work	LT-43
4.	Axle of wheels and steering system	every 20 h of work	LT-43
5.	Axle guide	every 20 h of work	LT – 43

5.4. Raker storage

1-rotor carousel raker Z206 should be kept under a roof on the flat, solid ground in a place posing no threat to people and surrounding. When stored, a raker shall lean at the front against a support and at the back on two wheels. Power input connection ending shall be covered with a layer of thick grease. It is possible to keep it outside, in case of abraded protective layer maintenance should be repeated. Each loss in the paint layer should be filled. Light and warning signs and a triangular sign for low-speed vehicles and a PTO shaft should be dismantled from the machine and placed in a dry room, to be protected from being damaged. After period of storage, the machine shall be greased and screw connections inspected.

5.6. Possible failure

To ensure a lasting and reliable operation of the raker, condition of screw connections shall be checked and tightened in case of loosening. After work, the raker should be cleaned thoroughly. Worn or damaged working parts shall be replaced. Most common causes of failure, their symptoms and ways of removal are listed in table 3.

Table 3. Causes of failure and ways of removal

No	Symptoms	Causes	Way of removal
1.	Windrow contaminated with soil lumps	Spring fingers set too low	Check and adjust setting the fingers
		Wrong longitudinal leveling	Check and perform longitudinal leveling if need be
2.	After machine operation, grass blades are not touched	Spring fingers set too high	Check and adjust setting the fingers
		Wrong longitudinal leveling	Check and perform longitudinal leveling if need be

6. TRANSPORTATION OF A CAROUSEL RAKER

6.1. Raker transportation by means of transport

1-rotor carousel raker Z206 can be transported from the manufacturer to the sales person or client by trucks. Rakers are transported partly disassembled into main subassemblies (for example on pallets). Rakers, if transported assembled, are loaded onto truck trailers with lifting devices after installing lines or chains in places marked by the manufacturer. The raker should

be secured still on means of transport, the transporting person is responsible for proper securing the raker.



DANGER

When loading rakers on means of transport, lines or chains shall be installed in places marked with pictograms.

6.2. Transportation of a raker on the tractor three-point suspension system

1-rotor carousel raker transported on public roads on a tractor suspension system should be equipped with portable light and warning devices having at the back combination lamps with lights: side and red brake, yellow turning and red reflective one. On the machine there must be a triangular sign for low speed vehicles placed. Besides, the tractor on which the raker is suspended should comply conditions allowing it to move on public roads in compliance with binding requirements.

Changing operation - transportation position

In order to gain transportation position, do as follows:

- turn off the drive and wait until all machine parts stop,
- place arms with spring fingers in special handles on the machine frame,
- lift the protective barrier (right side) and secure with a cotter pin,
- lift the shield forming windrow (left side) and secure with a cotter pin.
- at the back onto handles install signs with combination lights and a triangle sign,
- raise the raker on the three-point suspension system of the tractor until the transportation clearance is gained,
- the support should be raised and secured with a pin.

During transportation the raker should be lifted up to the position ensuring required transportation clearance. When turning, pay attention to “overlapping” of the machine. Light and warning signs and a triangular sign for low-speed vehicles should be kept clean.



DANGER

It is forbidden to move on public roads without the proper marking and lights in accordance with applicable regulations. Raker transported on a tractor suspension system, on public roads must be obligatory equipped with portable light and warning devices and a triangular sign for low-speed vehicles installed in special handles at the back of the machine. It is forbidden to transport people or cargo on the frame of the machine.

7. DISASSEMBLY

Disassembly of the machine should be performed by people previously acquainted with its construction, equipped with personal protective equipment (gloves). These activities should be done after setting the machine on the flat and solid ground. Disassembly and changing the working parts (spring fingers) should be performed according to the tables included in the spare parts catalogue. In case of worn parts, follow ‘Totaling’ point.

Due to a number of raker parts exceeding 20 kg (frame), during disassembly use lifting devices.



CAUTION

Lifting devices used during disassembly can be operated by a person properly authorized and qualified.

8. TOTALING

Totaling of the carousel raker shall be performed after its previous complete disassembly and inspection of the machine parts. During disassembly, parts should be grouped according to the material type: plastic materials, ferrous metals.

Used lubricants shall be passed to a chain of points collecting them, where they are processed in order to be re-used. Worn parts made from ferrous metals shall be grouped and passed to points purchasing these metals.

9. TECHNICAL CHARACTERISTICS

1-rotor carousel raker Z206 technical data is listed in table 4.

Table 4. Technical characteristics of the raker

Specification	Unit of measure	Data	Data
1	2	3	3
Machine symbol	-	Z206	Z206/1
Machine type	-	mountable	mountable
Overall dimensions in working and transportation position			
- length	mm	3460/2850	4350/3750
- width	mm	3300/1220	4200/1700
- height	mm	1200/2350	1200/2650
Machine weight	kg	410	570
Working width	m	3.5	4.4
Aggregating with a tractor			
- tractor class	-	min. 0.6	min. 0.6
- pulling force	kN	min. 6	min. 9
- power demand	kW	25	34
Working parts characteristics			
- working mechanism type	-	arms with spring fingers	arms with spring fingers
- arms number	item	9	11
- spring fingers number	item	9x3 double fingers	11x4 double fingers
Transportation clearance	mm	min 300	min 300

Rotations number of working parts	rpm	340	340
Maximum transportation speed	km/h	15	15
Working speed	km/h	6 – 12	6 - 12
Wheels and steering system:			
- wheels number	item	4	4
- wheels diameter	mm	300	300
- wheels track	mm	1200	1200
- tires	-	15x6.00 6PR	15x6.00 6PR
- pressure	bar	2	2
PTO shaft			
- size	-	2	2
- torque	Nm	250	250
- transmitted power	kW	14	14
- retracted shaft length between crosspieces	mm	690	690
- ending (inlets)			
- from the tractor/machine side	-	6/6	6/6
- power take-off shaft working rotations	rpm	540	540
Shafts used should have CE mark			

Measurements of geometric dimensions and weights are given in the technical characteristic to an accuracy of 1%.

SPARE PARTS CATALOGUE

How to use the catalogue.

Spare parts catalogue includes figures and tables of 1-rotor carousel raker assemblies.

The catalogue should be used as follows:

- determine the proper assembly the damaged part belongs to according to the tables,
- find the needed part on the assembly table following the reference number from the assembly drawing.

Spare parts can be purchased at the raker manufacturer, by writing to his address or by calling; then you are supposed to specify:

- the exact address of the client,
- raker serial number,
- raker symbol,
- year of production,
- manual issue number,
- the exact name of parts or assembly,
- Catalogue symbol (KTM), spare part number or standard,
- number of pieces,
- payment terms.

All standard parts can be purchased in the public sale.

Table 1. 1-rotor raker

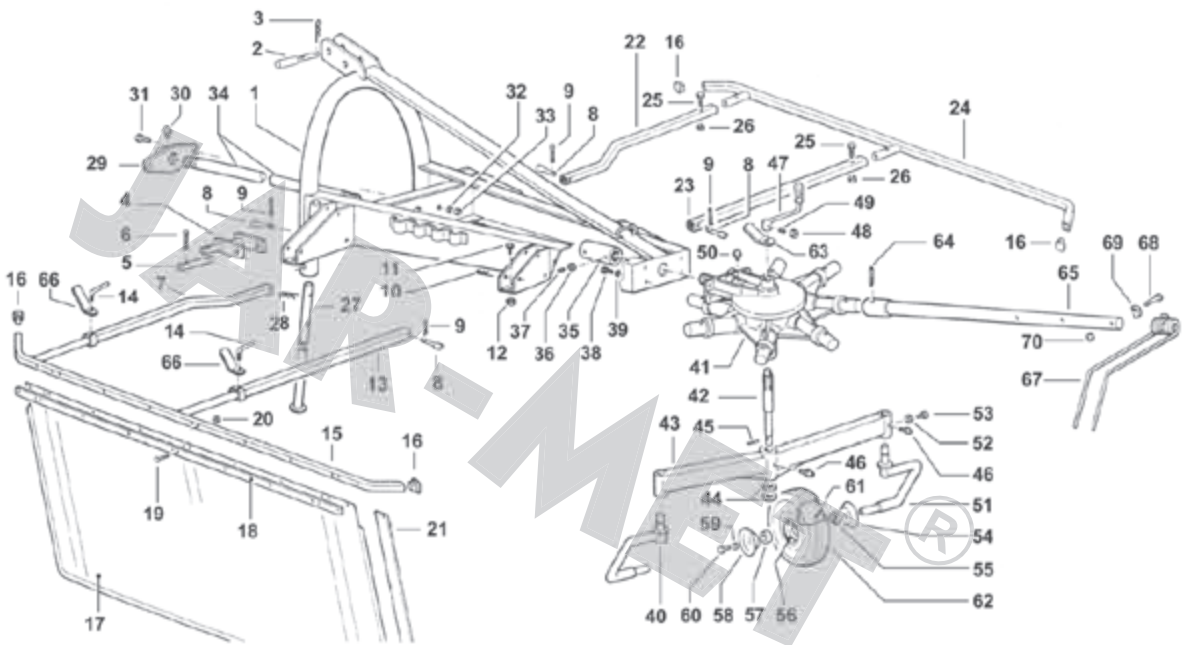

WARRANTY CARD

1-rotor carousel raker

Machine symbol	
Serial number	
Production date	
Date of sale	
Seller signature
		Seller stamp

CAUTION: It is seller's obligation to fill in the warranty card and complaint forms carefully (legibly). Lack of for example date of sale or stamp of sales point will put the user at risk of not acknowledging possible complaints. Warranty card with any written corrections or filled in illegibly – is invalid.

Warranty proceedings rules

1. A user is understood as a natural or legal person purchasing an agricultural equipment and a seller – as a corporate unit providing equipment to the user and a manufacturer - as a producer of agricultural equipment.
2. Manufacturer ensures good quality and efficient operation of the carousel raker, to which the warranty card is attached.
3. Any defects or damage of the carousel raker shall be fixed free of charge at the place of the purchaser in the period of 12 months from the sales date.
4. Any revealed defects or damages shall be reported in person, by post mail or by phone.
5. If during warranty period, occurs a necessity of performing 3 warranty repairs and the product will still reveal defects disabling its usage according to its intended use, the purchaser is entitled to have the product exchanged into a new, flawless one or refund.
6. If the manufacturer, a seller and a user will not establish another deadline for considering the complaint, exchanging the product or refund, it should be made within 14 days from the date of reporting it by the user.
7. If due to the warranty, a part of the machine has been exchanged or repaired and its cost exceeds 30% of the value of the new machine, warranty period starts all over again from the date of giving the new or repaired part.
8. Warranty repairs do not cover repairs caused by:
 - using the raker inconsistently with the manual and intended use,
 - acts of God or others for which the guarantor does not take responsibility.After warranty repairs can be performed only at the user/purchaser cost.
9. Guarantor can cancel warranty on the product in case of stating:
 - introducing structural changes and interference in internal parts of the machine,
 - occurring any damages caused by acts of God,
 - lack of necessary records or made by one's own any records in the warranty card,
 - using the raker inconsistently with intended use or manual.

Complaint form no 1

Mountable carousel raker type.....
Serial number..... Date of purchase.....

.....
Seller's signature and stamp

Complaint protocol number.....

Complaint form no 2

Mountable carousel raker type.....
Serial number..... Date of purchase.....

.....
Seller's signature and stamp

Complaint protocol number.....

Complaint form no 3

Mountable carousel raker type.....
Serial number..... Date of purchase.....

.....
Seller's signature and stamp

Complaint protocol number.....

After repair I received technically efficient machine
on..... (date)

User's signature.....

Notices:

.....
.....
.....

After repair I received technically efficient machine
on..... (date)

User's signature.....

Notices:

.....
.....
.....

After repair I received technically efficient machine
on..... (date)

User's signature.....

Notices:

.....
.....
.....

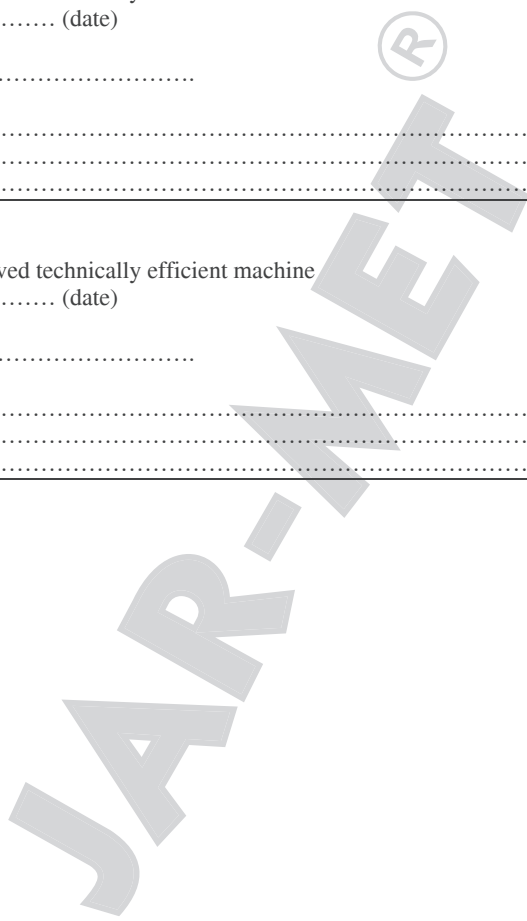

Complaint form no 1

Mountable carousel raker type.....
Serial number..... Date of purchase.....

.....
Seller's signature and stamp

Complaint protocol number.....

Complaint form no 2

Mountable carousel raker type.....
Serial number..... Date of purchase.....

.....
Seller's signature and stamp

Complaint protocol number.....

Complaint form no 3

Mountable carousel raker type.....
Serial number..... Date of purchase.....

.....
Seller's signature and stamp

Complaint protocol number.....

After repair I received technically efficient machine
on..... (date)

User's signature.....

Notices:

.....
.....
.....

After repair I received technically efficient machine
on..... (date)

User's signature.....

Notices:

.....
.....
.....

After repair I received technically efficient machine
on..... (date)

User's signature.....

Notices:

.....
.....
.....

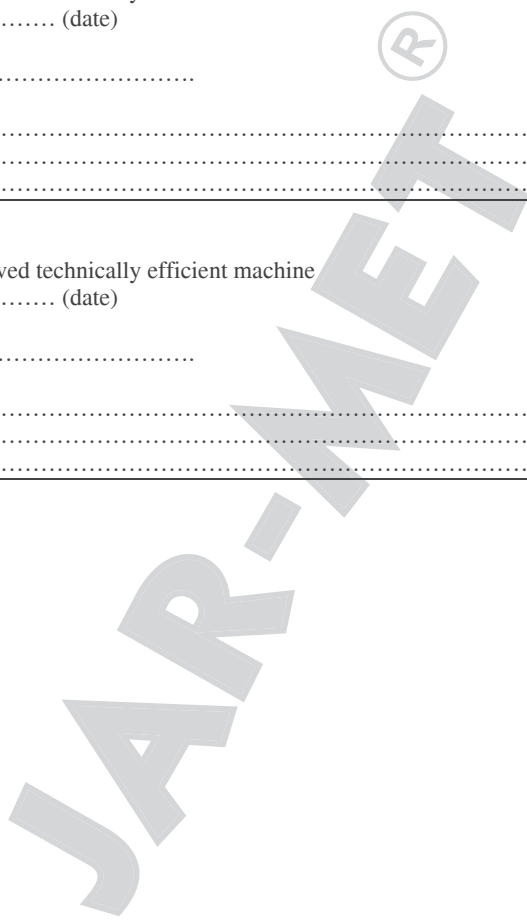

WWW.MARGUCIAI.LT

INFO@MARGUCIAI.LT

Nauja technika: +370 685 54521

Naudota technika iš Danijos: +370 656 24532

Lenkiškos technikos atsarginės dalys: +370 615 68799

Skandinaviškos technikos atsarginės dalys: +370 682 51607

Farmtrac atsarginės dalys: +370 626 19138

Chemikalų purkštuvai, patikra: +370 616 55819

Fermų įranga: +370 626 19138

Servisas: +370 682 51607

Marketingas: +370 690 70226

Buhalterė: +370 616 55738

Direktorė: +370 699 73969

MARGUČIŲ G. 3, MARGUČIŲ K., MIEŽIŠKIŲ SEN., PANEVŽIO RAJ., LT-38100



Vieninteliai atstovai Lietuvoje

FARMTRAC
TRACTORS EUROPE



AKPIL®
FRANCE



MCMs
Warka Sp. z o.o.

